

AI 12X/20X/23X Mini PTZ Dome Network Camera

NDAA

IP66

IK10

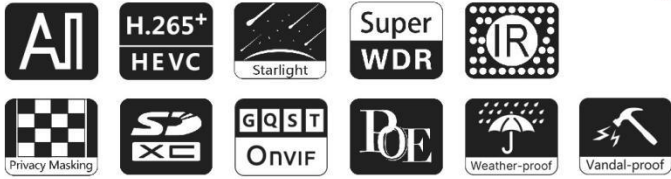

DATASHEET

KEY FEATURES

- ▶ NDAA Compliance (Milesight Fully NDAA-compliant products are well suited for government, defense and a range of projects subject to the NDAA.)
- ▶ 0.001Lux Starlight (Delivering detailed color image even in the low light environments reaching 0.001Lux(Color) or 0Lux(B/W).)
- ▶ 120dB Super WDR (Excellent performance even when the ratio of the luminosity of brightest and darkest is up to 120dB.)
- ▶ Advanced Functions (Boasting to support various advanced functions such as HLC, ROI.)
- ▶ 300 Preset Positions (The user can easily control the lens position via mouse to monitor interested area and set up to 300 preset positions for patrolling.)
- ▶ Keyboard Control (Shortcut keys for PTZ control via Milesight Keyboard.)
- ▶ Smart Stream (Bandwidth, storage and bit rate are saved with Smart Stream On, eg, H.265+ saves 70%~80% bandwidth that of H.264.)

AI Video Analytics

- 8 intelligent VCA modes powered by AI engine, which can intelligently filter objects to focus on human and vehicle detection.
- People Counting technology provides high accuracy and real-time data based on AI algorithm with statistic reports.



Smart IR II Technology

It allows the camera to catch better images regardless of object distance with High Beams and Low Beams whose brightness could be adjusted manually or automatically. Also, the innovative IR Anti-reflection Panel protects the lens from IR interference.



High Speed & Precise Movement

With a sophisticated pan/tilt mechanism, the 12X/20X/23X AI Mini PTZ Dome Network Camera provides fast, precise movement with 360° endless pan and -5~90° (Auto Flip). Maximum pan speed of 450°/s and tilt speed of 360°/s make the camera a mighty Speed Dome model.



Recessed Installation

With recessed installation, the 12X/20X/23X AI Mini PTZ Dome Network Camera is easily blend in with the environment to provide discreet surveillance.

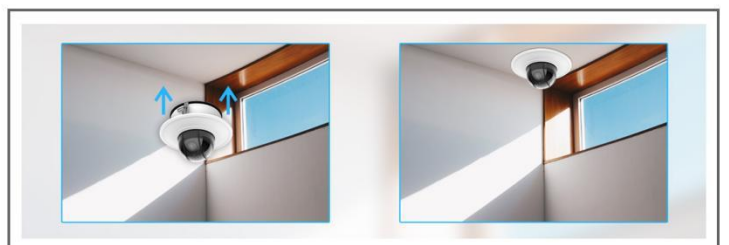

AI 12X/20X/23X Mini PTZ Dome Network Camera



	Model	MS-C2971-X12TPA (2MP)	MS-C2871-X20TPA (2MP)	MS-C2971-X23TPA (2MP)
Camera	Image Sensor	1/2.8" Progressive Scan CMOS	1/2" Progressive Scan CMOS	1/2.8" Progressive Scan CMOS
	Min. Illumination	Color: 0.002Lux@F1.2	Color: 0.001Lux@F1.2	Color: 0.002Lux@F1.2
		Color: 0.005Lux@F1.6	Color: 0.002Lux@F1.6	Color: 0.005Lux@F1.5
		B/W: 0Lux with IR on	B/W: 0Lux with IR on	B/W: 0Lux with IR on
	WDR	120dB Super WDR		
	Shutter Time	1/100000s~1s		
	Digital Zoom	16X		
	Day/Night Mode	Day/Night/Auto/Customize/Schedule		
S/N	>55dB			
Lens	Focal Length	5.3~64mm, 12X Optical Zoom	6.4~128mm, 20X Optical Zoom	5~117mm, 23X Optical Zoom
	Zoom Speed	Approx 4s (Wide-Tele)	Approx 5s (Wide-Tele)	Approx 6s (Wide-Tele)
	Field of View	H61°~H5°/D69°~D5°/ V36°~V2°	H60°~H3°/D67°~D4°/ V37°~V1°	H60°~H3°/D69°~D4°/ V35°~V2°
	Focus Control	Auto/Semi-Auto/Manual		
	Minimum Working Distance	1000/1500mm (Wide/Tele)	100/2000mm (Wide/Tele)	100/1500mm (Wide/Tele)
	Aperture	F1.6~F2.8	F1.6~F4.0	F1.5~F3.5
	Iris Control	Auto		
PTZ	Pan Range / Pan Speed	360° endless; Pan Manual Speed: 0.1°~450°/s, Pan Preset Speed: 450°/s		
	Tilt Range / Tilt Speed	-5°~90° (Auto Flip); Tilt Manual Speed: 0.1°~360°/s, Tilt Preset Speed: 360°/s		
	Proportional Zoom	Support		
	Preset Quantity	300		
	Patrol	8 Patrols, up to 48 presets each patrol		
	Pattern	4 Patterns		
	Power Off Memory	Support		
	Other Function	Auto Scan, Auto Home, Preset Freezing, 3D Positioning, PTZ Limits, Initial Position		
IR	IR Distance	Up to 160m		
	IR Angle	Auto/Manual		
Video	Max. Image Resolution	1920x1080		
	Primary Stream	60Hz/50Hz: 90fps@(1920x1080, 1280x960, 1280x720, 704x576)		
	Secondary Stream	60Hz/50Hz: 90fps@(704x576, 640x480, 640x360, 352x288, 320x240, 320x192, 320x180)		
	Tertiary Stream	60Hz: 30fps@(1280x720, 704x576, 640x480, 640x360, 320x240, 320x192, 320x180) 50Hz: 25fps@(1280x720, 704x576, 640x480, 640x360, 320x240, 320x192, 320x180)		
	Video Compression	H.265+/H.265(HEVC)/H.264+/H.264/MJPEG		
	Video Bit Rate	16Kbps~16Mbps(CBR/VBR Adjustable)		
	Privacy Masking	Up to 8 areas		
	ROI	Up to 8 areas		
	Image Setting	Brightness/Contrast/Saturation/Sharpness		
Interface	Ethernet	1*RJ45 10M/100M Ethernet Port		
	Audio I/O	1/1		
	Alarm I/O	1/1		

AI 12X/20X/23X Mini PTZ Dome Network Camera



Network	Network Storage	NAS(Support NFS, SMB/CIFS), ANR
	Protocol	IPv4/IPv6, ARP, TCP, UDP, RTCP, RTP, RTSP, RTMP, HTTP, HTTPS, DNS, DDNS, DHCP, FTP, NTP, SMTP, SNMP, UPnP, Bonjour, SIP, PPPoE, VLAN, 802.1x, QoS, IGMP, ICMP, SSL
Audio	Audio Compression	G.711/AAC/G.722/G.726
	Audio Sampling Rate	8/16/32/44.1/48KHz
	Audio Bit Rate	16~256kbps
	Two-way Audio	Support
Intelligent Analytics	Video Analysis	Region Entrance, Region Exiting, Advanced Motion Detection, Tamper Detection, Line Crossing, Loitering, Object Left, Object Removed
	People Counting&Report	Count the number of people entering or exiting
System	Storage	Support microSD/SDHC/SDXC Card Local Storage, up to 256G
	Advanced Function	BLC, HLC, 2D DNR, 3D DNR, AWB, IP Address Filtering, AGC, Anti-flicker, Corridor Mode, Deblur, Watermark
	SIP/VoIP Support	Yes, Voice & Video-over-IP
	Event Trigger	Motion Detection, Network Disconnection, External Input, Audio Alarm, etc.
	Event Action	FTP Upload, SMTP Upload, SD Card Record, External Output, SIP Phone, PTZ Motion, HTTP Notification, etc.
	System Compatibility	ONVIF Profile G & Q & S & T, API
General	Working Condition	Temperature: -40°C~60°C / Humidity: 0~90%(Non-condensing)
	Power Supply	PoE (802.3at) / DC 12V/3A ± 10%
	Power Consumption	12W MAX 20W MAX (With IR on)
	Weather Proof/Housing	Up to IP66-rated for Weather-resistant Performance / Vandal-proof IK10-rated Metal Housing
	Surge Protection	4KV
	Dimensions/Weight	Φ183mmX174.8mm/2Kg
	Warranty	2 Years / 3 Years (Optional)

AI 12X/20X/23X Mini PTZ Dome Network Camera



Structure Diagrams

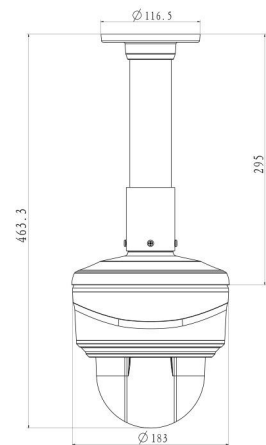
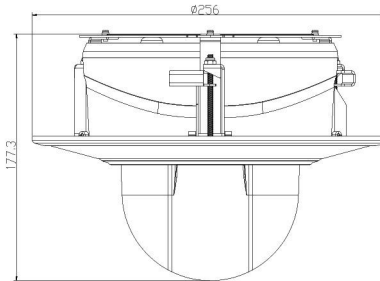
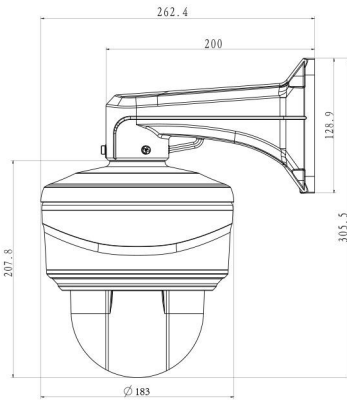
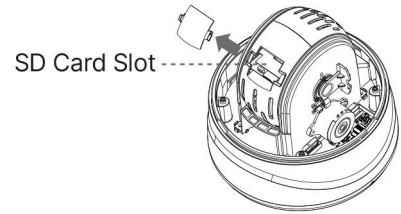
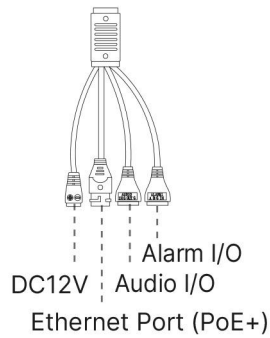
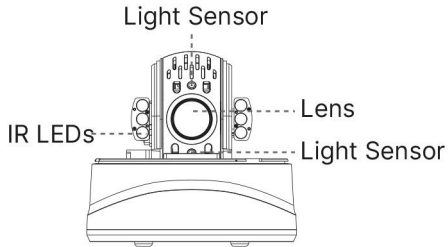

Units: mm

Accessories Support

A01 Pole Mount

Weight: 720g
Dimensions: 170*51.5*152.6mm



A03 External Corner Bracket

Weight: 900g
Dimensions: 170*152.5*76.3mm



A42-L Extension Lever

Weight: 325g
Dimensions: 57*255mm



A43 Junction Box

Weight: 1000g
Dimensions: 195*164*80mm



A77 Wall Mount

Weight: 650g
Dimensions: 262*185*138mm



A78 Recessed Mount

Weight: 715g
Dimensions: Φ256*94mm



A79 Pendant Mount

Weight: 850g
Dimensions: Φ185*295mm



AC-71 Smoked Dome Cover

For concealing where a camera is pointed



MileSight Technology Co., Ltd. | www.milesight.com

Contact Us: sales@milesight.com support@milesight.com

Add: 220 NE 51st Street, Oakland Park, Florida 33334, USA
Tel: +1-800-561-0485

Add: 925, Anyang SK V1 Center, LS-ro 116beon-gil, Dongan-gu, Anyang-si, Korea
Tel: +82-31-990-7732

Add: No.23 Wanghai Road, 2nd Software Park, Xiamen, China
Tel: +86-592-5922772

