

AI 12X/20X/23X Mini PTZ Dome Network Camera



IP66
IK10



KEY FEATURES

- ▶ 0.001Lux Starlight (Delivering detailed color image even in the low light environments reaching 0.001Lux(Color) or 0Lux(B/W).)
- ▶ 140dB Super WDR (Excellent performance even when the ratio of the luminosity of brightest and darkest is up to 140dB.)
- ▶ Advanced Functions (Boasting to support various advanced functions such as HLC, Defog, ROI.)
- ▶ Intelligent Auto Tracking (Intelligent Pan/Tilt/Zoom to precisely track the detected human and vehicle.)
- ▶ 100fps High Frame Rate (Camera can easily catch images with no latency despite of the high-speed movement.)
- ▶ 12X/20X/23X Optical Zoom (Zooming up to distant subjects while still maintaining clarity.)
- ▶ Keyboard Control (Shortcut keys for PTZ control via Milesight Keyboard.)
- ▶ Smart Stream (Bandwidth, storage and bit rate are saved with Smart Stream On, eg, H.265+ saves 70%~80% bandwidth that of H.264.)

AI Video Analytics

- 8 intelligent VCA modes powered by AI engine, which can intelligently filter objects to focus on human and vehicle detection.
- People Counting technology provides high accuracy and real-time data based on AI algorithm with statistic reports.
- Face Detection function detects human faces in the monitoring scene and captures the snapshots, which greatly enhances the monitoring efficiency.



Smart IR II Technology

It allows the camera to catch better images regardless of object distance with High Beams and Low Beams whose brightness could be adjusted manually or automatically. Also, the innovative IR Anti-reflection Panel protects the lens from IR interference.



High Speed & Precise Movement

With a sophisticated pan/tilt mechanism, the 12X/20X/23X AI Mini PTZ Dome Network Camera provides fast, precise movement with 360° endless pan and -5~90° (Auto Flip). Maximum pan speed of 450°/s and tilt speed of 360°/s make the camera a mighty Speed Dome model.



Recessed Installation

With recessed installation, the 12X/20X/23X AI Mini PTZ Dome Network Camera is easily blend in with the environment to provide discreet surveillance.

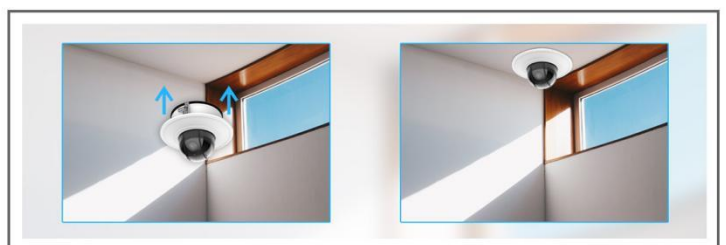

AI 12X/20X/23X Mini PTZ Dome Network Camera



	Model	MS-C2971-X12R(T)PC (2MP)	MS-C2871-X20R(T)PC (2MP)	MS-C2971-X23R(T)PC (2MP)	MS-C5371-X12PC (5MP)
Camera	Image Sensor	1/2.8" Progressive Scan CMOS	1/2" Progressive Scan CMOS	1/2.8" Progressive Scan CMOS	
	Min. Illumination	Color: 0.002Lux@F1.2	Color: 0.001Lux@F1.2	Color: 0.002Lux@F1.2	Color: 0.005Lux@F1.2
		Color: 0.005Lux@F1.6	Color: 0.002Lux@F1.6	Color: 0.005Lux@F1.5	Color: 0.008Lux@F1.6
		B/W: 0Lux with IR on	B/W: 0Lux with IR on	B/W: 0Lux with IR on	B/W: 0Lux with IR on
	WDR	140dB Super WDR (Super WDR Pro is optional for T Series)			120dB Super WDR
	Shutter Time	1/1000000s~1s			
	Digital Zoom	16X			
	Day/Night Mode	Day/Night/Auto/Customize/Schedule			
S/N	>55dB				
Lens	Focal Length	5.3~64mm, 12X Optical Zoom	6.4~128mm, 20X Optical Zoom	5~117mm, 23X Optical Zoom	5.3~64mm, 12X Optical Zoom
	Zoom Speed	Approx 4s (Wide-Tele)	Approx 5s (Wide-Tele)	Approx 6s (Wide-Tele)	Approx 4s (Wide-Tele)
	Field of View	H61°~H5°/D69°~D5°/ V36°~V2°	H60°~H3°/D67°~D4°/ V37°~V1°	H60°~H3°/D69°~D4°/ V35°~V2°	H57°~H4°/D69°~D5°/ V44°~V1°
	Focus Control	Auto/Semi-Auto/Manual			
	Minimum Working Distance	1000/1500mm (Wide/Tele)	100/2000mm (Wide/Tele)	100/1500mm (Wide/Tele)	100/1500mm (Wide/Tele)
	Aperture	F1.6~F2.8	F1.6~F4.0	F1.5~F3.5	F1.6~F2.8
Iris Control	Auto				
PTZ	Pan Range / Pan Speed	360° endless; Pan Manual Speed: 0.1°~450°/s, Pan Preset Speed: 450°/s			
	Tilt Range / Tilt Speed	-5°~90° (Auto Flip); Tilt Manual Speed: 0.1°~360°/s, Tilt Preset Speed: 360°/s			
	Proportional Zoom	Support			
	Preset Quantity	300			
	Patrol	8 Patrols, up to 48 presets each patrol			
	Pattern	4 Patterns			
	Auto Tracking	Support			
	Power Off Memory	Support			
	Other Function	Auto Scan, Auto Home, Preset Freezing, 3D Positioning, PTZ Limits, Initial Position			
IR	IR Distance	Up to 160m			
	IR Angle	Auto/Manual			
Video	Max. Image Resolution	1920x1080			2592x1944
	Primary Stream	60Hz: 100fps@(1920x1080)(Optional for T Series) , 60fps@(1920x1080, 1280x960, 1280x720, 704x576)			60Hz: 30fps@(2592x1944), 45fps@(2048x1536), 60fps@(1920x1080, 1280x960, 1280x720, 704x576)
		50Hz: 100fps@(1920x1080)(Optional for T Series) , 50fps@(1920x1080, 1280x960, 1280x720, 704x576)			50Hz: 25fps@(2592x1944), 45fps@(2048x1536), 50fps@(1920x1080, 1280x960, 1280x720, 704x576)
	Secondary Stream	60Hz: 30fps@(704x576, 640x480, 640x360, 352x288, 320x240, 320x192, 320x180) 50Hz: 25fps@(704x576, 640x480, 640x360, 352x288, 320x240, 320x192, 320x180)			
Tertiary Stream	60Hz: 30fps@(1920x1080, 1280x720, 704x576, 640x480, 640x360, 320x240, 320x192, 320x180) 50Hz: 25fps@(1920x1080, 1280x720, 704x576, 640x480, 640x360, 320x240, 320x192, 320x180)				

AI 12X/20X/23X Mini PTZ Dome Network Camera



	Video Compression	H.265+/H.265(HEVC)/H.264+/H.264/MJPEG
	Video Bit Rate	16Kbps~16Mbps(CBR/VBR Adjustable)
	Privacy Masking	Up to 24 areas
	ROI	Up to 8 areas
	Image Setting	Brightness/Contrast/Saturation/Sharpness
Interface	Ethernet	1*RJ45 10M/100M Ethernet Port
	Audio I/O	1/1
	Alarm I/O	1/1
Network	Network Storage	NAS(Support NFS, SMB/CIFS), ANR
	Protocol	IPv4/IPv6, ARP, TCP, UDP, RTCP, RTP, RTSP, RTMP, HTTP, HTTPS, DNS, DDNS, DHCP, FTP, NTP, SMTP, SNMP, UPnP, Bonjour, SIP, PPPoE, VLAN, 802.1x, QoS, IGMP, ICMP, SSL
Audio	Audio Compression	G.711/AAC/G.722/G.726
	Audio Sampling Rate	8/16/32/44.1/48KHz
	Audio Bit Rate	16~256kbps
	Two-way Audio	Support
Intelligent Analytics	Video Analysis	Region Entrance, Region Exiting, Advanced Motion Detection, Tamper Detection, Line Crossing, Loitering, Object Left, Object Removed
	Face detection	Detect and capture faces, get real-time snapshots
	People Counting&Report	Count the number of people entering or exiting, Up to 4 detection areas for regional people counting
System	Storage	Support microSD/SDHC/SDXC Card Local Storage, up to 256G
	Advanced Function	BLC, HLC, 2D DNR, 3D DNR, Defog, AWB, EIS, IP Address Filtering, AGC, Anti-flicker, Corridor Mode, Deblur, Watermark
	SIP/VoIP Support	Yes, Voice & Video-over-IP
	Event Trigger	Motion Detection, Network Disconnection, External Input, Audio Alarm, etc.
	Event Action	FTP Upload, SMTP Upload, SD Card Record, External Output, SIP Phone, PTZ Motion, HTTP Notification, etc.
	System Compatibility	ONVIF Profile G & Q & S & T, API
General	Working Condition	Temperature: -40°C~60°C / Humidity: 0~90%(Non-condensing)
	Power Supply	PoE (802.3at) / DC 12V/3A ±10%
	Power Consumption	11W MAX 19W MAX (With IR on)
	Weather Proof/Housing	Up to IP66-rated for Weather-resistant Performance / Vandal-proof IK10-rated Metal Housing
	Surge Protection	4KV
	Dimensions/Weight	Φ183mmX174.8mm/2Kg
	Warranty	2 Years / 3 Years (Optional)

AI 12X/20X/23X Mini PTZ Dome Network Camera



Structure Diagrams

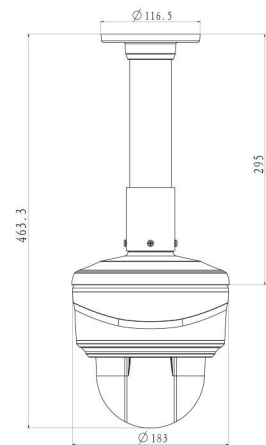
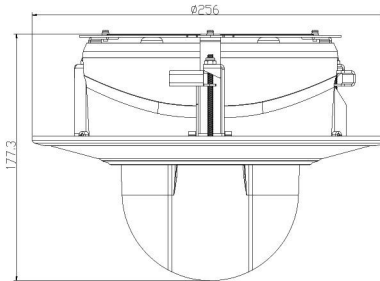
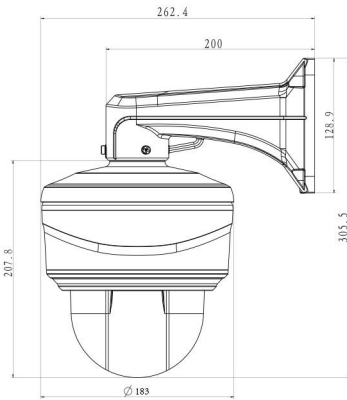
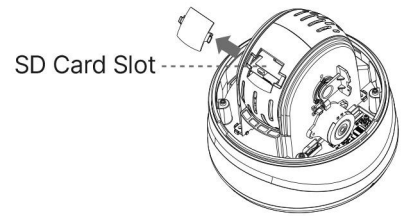
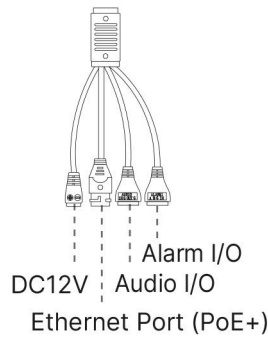
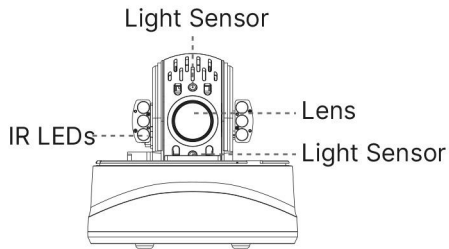

Units: mm

Accessories Support

A01 Pole Mount

Weight: 720g
Dimensions: 170*51.5*152.6mm



A03 External Corner Bracket

Weight: 900g
Dimensions: 170*152.5*76.3mm



A42-L Extension Lever

Weight: 325g
Dimensions: 57*255mm



A43 Junction Box

Weight: 1000g
Dimensions: 195*164*80mm



A77 Wall Mount

Weight: 650g
Dimensions: 262*185*138mm



A78 Recessed Mount

Weight: 715g
Dimensions: Φ256*94mm



A79 Pendant Mount

Weight: 850g
Dimensions: Φ185*295mm



AC-71 Smoked Dome Cover

For concealing where a camera is pointed



MileSight Technology Co., Ltd. | www.milesight.com

Contact Us: sales@milesight.com support@milesight.com

Add: 220 NE 51st Street, Oakland Park, Florida 33334, USA
Tel: +1-800-561-0485

Add: 925, Anyang SK V1 Center, LS-ro 116beon-gil, Dongan-gu, Anyang-si, Korea
Tel: +82-31-990-7732

Add: No.23 Wanghai Road, 2nd Software Park, Xiamen, China
Tel: +86-592-5922772

